

## Our Guide to Origami

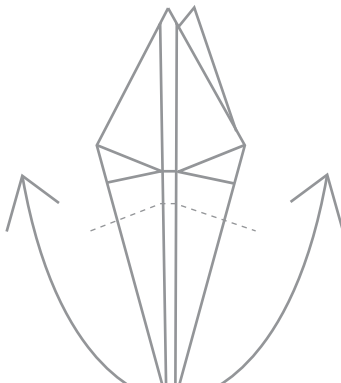
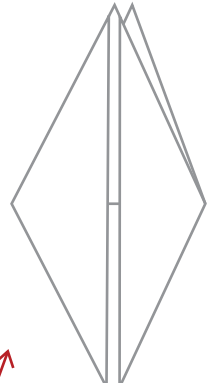
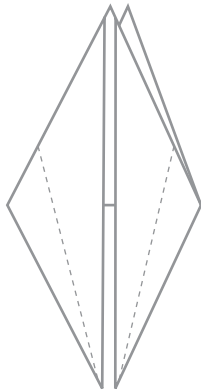
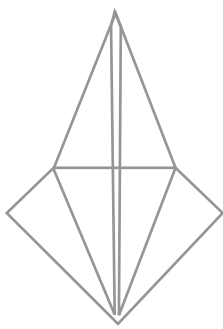
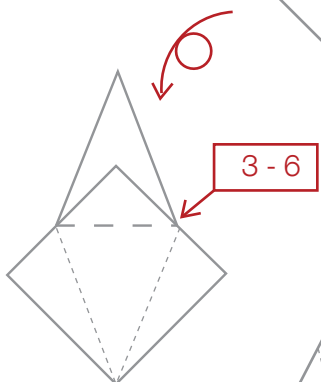
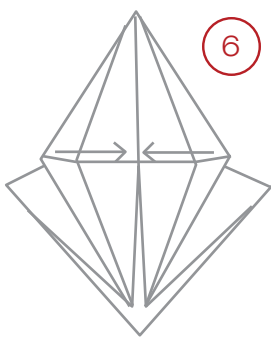
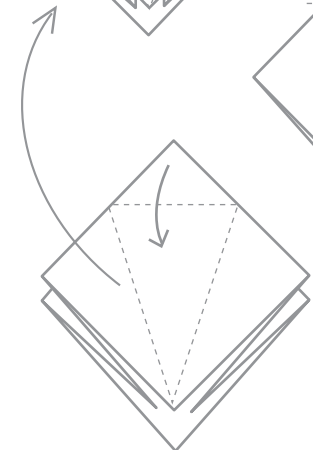
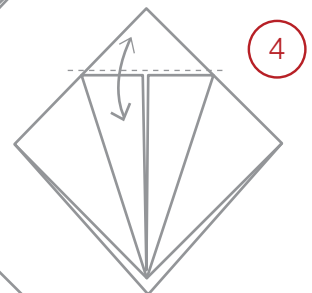
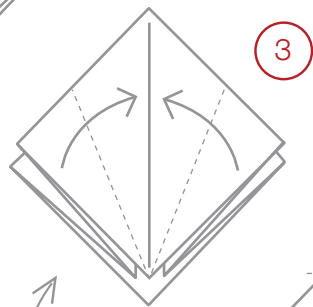
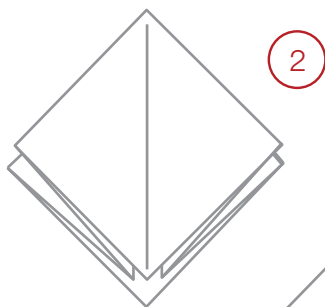
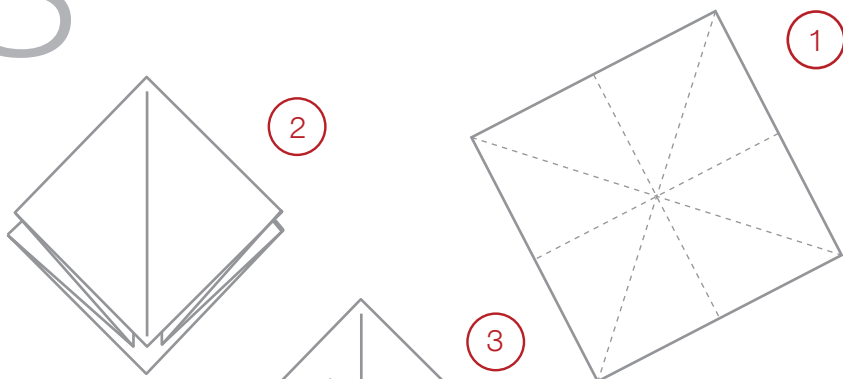

Bird Base

Repeat Behind

Reverse Fold

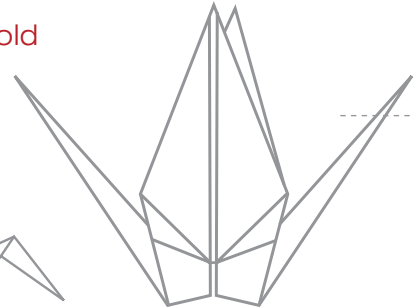

Reverse Fold

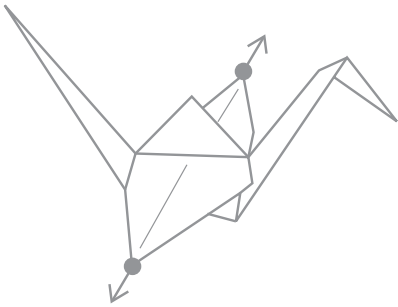
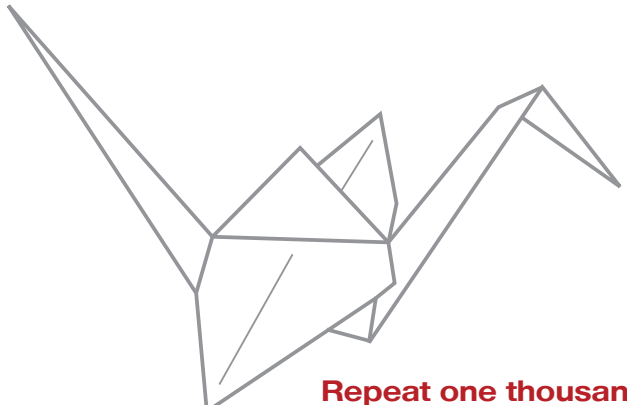

Repeat one thousand times for a wish!